

# **Kromski Polonaise**

## **Assembly Instructions**

### **Important Notice**

If you have any difficulty in understanding these instructions, assembling the wheel, or having it operate to its fullest potential, **WE WANT YOU TO CONTACT US. WE CAN HELP.**

If something does not fit, does not turn or rotate, looks unusual, or if, in spinning something seems wrong, **CALL US FOR CUSTOMER SERVICE. 252-398-4396** (this is in North Carolina) To reduce your expense, we will be happy to call you back on our “nickel.”

You may also e-mail us your telephone number and a convenient time to reach you (we will want you near the wheel) so we can help. Our e-mail: **mail@newvoyager.com**

Thank you

**New Voyager Trading**  
Distributor of Kromski products in North America



# Kromski Polonaise Spinning Wheel

First, thanks for choosing the Kromski Polonaise. We want your spinning experience to be enjoyable and the first thing to do is to assemble the wheel correctly and with care so that it works properly. We suggest you read through these instructions completely before you begin as this will resolve any questions you may have before they arise. You may also use the video that comes with your wheel, but we ask that you read these instructions as we may have updated or otherwise corrected information that is in the video.

After your wheel is assembled we will offer a few words of advice about adjusting it and maintenance.

## Finishing

If you purchased an unfinished wheel we suggest a finish of your choosing. A good wood stain and surface finish will help prevent a degree of staining from regular use and from the use of lubricating oil. Finishing a wheel prior to assembly is probably the best way to proceed. For a clear, natural look we suggest tung oil; otherwise, any quality stain and finishes is acceptable.

## Unboxing the wheel

The Polonaise was boxed in Poland and has traveled some distance to get to you so the first thing to do is to unbox the wheel, remove all the parts and check for any problems that may be obvious. If you observe a problem, contact your dealer.

Make sure all parts are unwrapped and set aside. Give yourself some room to work away from the parts so you don't step on anything. Smaller parts are in plastic bags so you may want to empty the bags and examine these items. Everything will go together easily so don't be concerned with the number of parts.

**Please refer to the detailed drawings that are attached and the video for additional information about putting your wheel together.**

## Step 1

The first step is to attach the rear leg. The base of the leg sits flat on the floor so you want to make sure you insert the leg into the bench hole correctly. Mark the leg and table, remove leg, apply wood glue to hole and re-insert leg making sure to match the two marks you made. Make sure the leg is "driven home" so it sits well into the hole. **Please do not glue the leg if you believe something has happened to these parts during shipment.**

Place the assembled parts on a very flat surface to make sure the rear leg sits flat on the surface.

## Step 2

Attach the mother-of-all table (this is the small table that is at the left side of the wheel) to the bench using the barrel nuts and bolts set (this consists of a hex-head bolt, a barrel nut (metal cylinder with threaded hole), a silver washer and a gold centering washer). The two holes on the end of the table will face towards the wheel. Put a barrel nut into each of predrilled holes in the two table legs (note that the nuts have a slot for a screwdriver; this should face out) and inserting a hex bolt with a washer and center washer up through the base of the bench into the table legs. If you find two of the four bolts in the parts bag to be shorter, use them at this location. Use a screwdriver to line up the barrel nut with the bolt, as needed. Using the supplied 4 mm hex wrench, snug the two bolts even and tight.

## Step 3

Find the two wheel support posts (these are the largest pieces of wood from all the parts) and two long threaded wheel adjustment screws (about 17" long). Refer to the parts pictures as needed. Carefully screw an adjustment screw

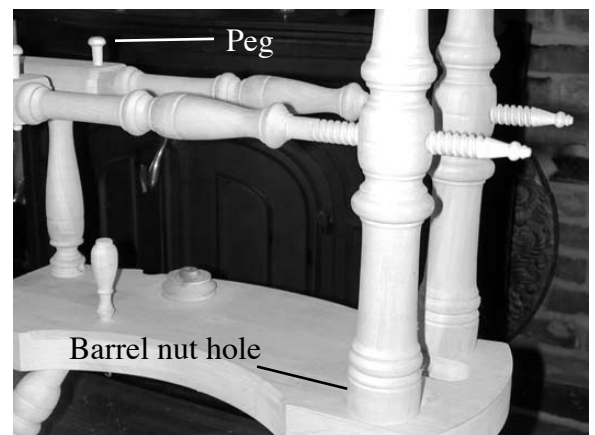
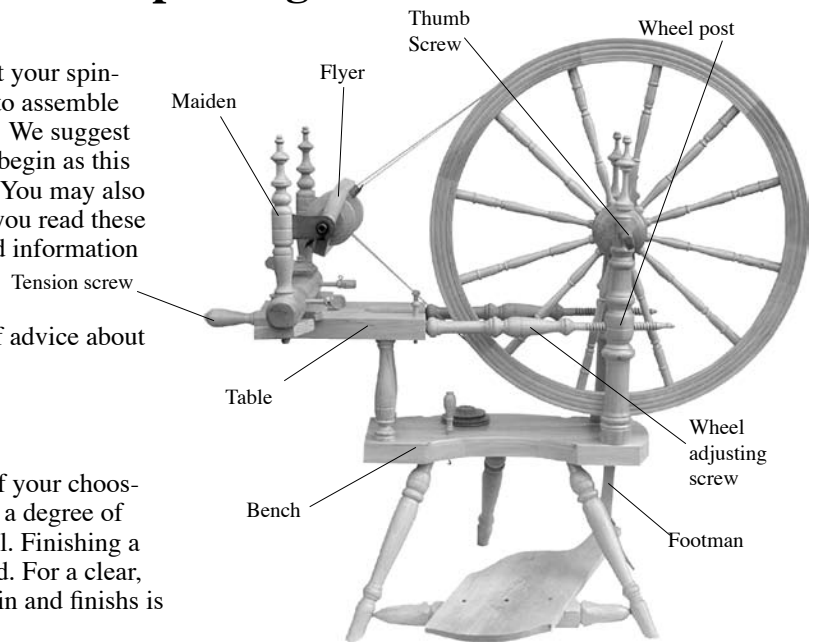

into each post, ensuring that the predrilled hole near the bottom of the post (a hole you will use for another barrel nut) is on the same side as the adjustment screw. Again, refer to a picture as needed.

Turn in the adjustment screw enough so that you can place the support posts into the bench and the adjustment screw can be lined up with the hole at the end of the mother-of-all table. Using the two remaining hex-head bolts, barrel nut, washer and center guide, attach the two posts to the bench by inserting the bolt assemblies up from the bottom of the bench into the post and through the barrel nut. Snug but do not tighten bolts yet; the post must be able to rotate a bit so you can do the next procedure.

Rotate the posts so you can line up and then back the adjustment screws into the holes at the end of the mother-of-all table. Do not put any pressure on the adjustment screw at this time since only one end is now supported. Continue to back in the adjustment screws until you can look down through the peg hole on the top of the table and see the peg groove on the adjustment screws. At this point you should insert a locking peg into each hole, securing the adjustment screws to the table but allowing them to rotate. **DO NOT ROTATE THESE SCREWS** after pegging. They must stay in a "neutral" position for the time being.

Now the wheel posts are properly aligned with the table and adjustment screws. Tighten the two hex bolts that hold the wheel posts so the posts are as rigid as can be.

#### Step 4

Now you will assemble the mother-of-all base (this refers to the structure that supports the flyer and bobbin above the table). This has been pre-assembled for you (it is the set of parts the included the maidens that have leather bearings).

Insert the tension adjusting screw through the end of the mother-of-all table. Screw through the wooden tension guide screw (with the threaded end pointed up) so that the notch on the adjusting screw can be lined up with the peg hole on the table. Insert a locking peg to secure the adjusting screw.

Rotate the rear maiden so the leather bearing is 90 degrees to the base and tighten the diamond shaped wood nuts on the front maiden. Place the pre-assemble mother-of-all onto the treaded guide screw and secure with the round mother-of-all lock nut. No need to attach the flyer at this time.

If you like, prior to the above step, you can first set the leather bearings of the two maidens in a cup of oil and allow it to wick up into the entire leather. (If you will be finishing the wheel make sure to finish first, then oil the leather bearings)

#### Step 5

Pre-position the drive band by making a double loop. Drop the loop over the front wheel post. This will allow you to fix the band around the wheel in just a moment.

The wheel on the Polonaise is supported and rotates on two metal pins that are embedded into the ends of two threaded wood thumb screws. Begin by attaching these two thumb screws from the outside of the wheel support posts. Screw in until about .25" of the screw comes through to the inside of the post.

Place the footman (long, flat piece of wood) on the wheel crank by working it into position using the large hole area on the footman.

Once it is up in position on the crank pull it down so the small end sits on the crank. In your parts bag are two small wooden pins. The long pin is used to secure the footman tightly to the crank by inserting it through the two holes at the top of the footman.

You will now hang the wheel. Bring the wheel and footman in between the two wheel support posts. Drop the bottom end of the footman through the hole in the wheel bench. Bring the hub of the wheel into position so that the metal cups on each side of the crank/hub line up with the pointed ends of the thumb screws coming through the posts. Holding the wheel with one hand, advance the thumb screws equally so that the metal pins nest into the metal cups on the crank. The wheel is properly supported when you can visually detect a slight deflection of the two wheel posts. If you can push from the outside in, on both thumb screws, and do not feel movement, you are probably set right. If in doubt, error on the side of a tighter fit. These bearing points are machined to nest nicely so more tension is not a problem.



Maidens, mother-of-all, table

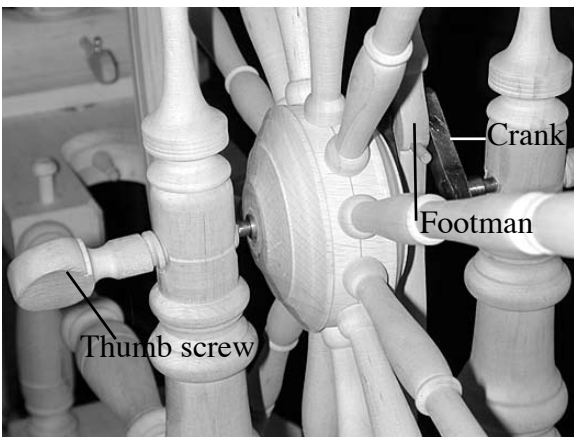

Attach the footman to the treadle using the leather strap from the parts bag. Lace the leather footman tie through the hole on the footman then push both ends through the hole on the top of the treadle. Wrap both ends around the sides of the treadle, bring up and tie off as tight as you can. There should be no slack in the connection between the end of the footman and the treadle. When done, you want to make sure the footman does not come into contact with the bench hole as the wheel makes its rotation. If the footman touches the bench, adjusting the thumb screws equal amounts to move the wheel and footman towards the front or back, as needed, so the footman does not touch the table. It is a good idea to first wax the strap with a candle or paraffin to reduce noise caused by flexing during spinning.

## Step 6

Now there are a number of small jobs to complete before you spin. You can now attach the fancy ends to the top of the two wheel posts. We do not recommend gluing.

The Polonaise uses three thumb pegs to implement the scotch tension setup. (If you do not intend to use Scotch tension you may skip this step.) Two thumb pegs have metal eye bolts on them, one has a hole in its shaft. This last thumb peg goes in the hole closest to the spinner. Insert the other thumb pegs into their holes on the base of the mother-of-all. You will attach the brake band in a moment.

The Polonaise comes with two whorls. Assemble the flyer with a bobbin and a whorl. **WARNING: AS WITH MOST DOUBLE DRIVE WHEELS, THE WHORLS AND SPINDLE SHAFT ARE REVERSE THREADED. DO NOT ATTEMPT TO ATTACH THE WHORL IN THE WRONG DIRECTION. GOING ON, TURN IN A COUNTER-CLOCKWISE DIRECTION. CLOCKWISE TO REMOVE. DON'T LET CHILDREN PLAY WITH THIS.**

For anyone new to double drive spinning, note that there are two different size pulleys on the bobbin. Depending on the size of the whorl you are using, always make sure that the bobbin pulley being used is smaller than the whorl groove you are using.

On the metal spindle you will find a small brass spacer at the base of the spindle. It is important that this remain on the shaft all the time. If it is not on the shaft check the parts bag.

Bring the drive band up and place over and around the wheel. Now move the mother-of-all towards the wheel by turning the tension screw accordingly. Holding the flyer, lay one strand of the drive band over a groove on the whorl and the other over the pulley of the bobbin and assemble the flyer on the leather bearings, adjusting the front maiden to get a proper fit. Tighten the front maiden into position. There is some play here and you can adjust to your liking. The flyer should float a bit, front to back. Using the tension adjusting screw, move the mother-of-all to the left until you have proper tension on the drive band.

Find the remaining short wooden pin in the parts bag and insert it into the predrilled hole on the top back of the bench. You will use this to store your extra whorls. The threading hook goes into the hole on the bench. Bend the wire on the hook to suit your needs.

**Scotch Tension** - The brake band parts for scotch tension are in the parts bag - 3 thumb pegs (2 with eye screws attached), band with spring attached. Connect the spring to the eye bolt on one peg and place peg into the hole on the left rear of the mother-of-all base (eye points up). Loop the string over the rear bobbin pulley, down to the other peg place in right rear hole, thread through the eye then forward to the adjusting knob. Secure by tying the string through the hole in the peg with enough slack to allow you to wind the string around the peg as you apply brake to the bobbin. If you are not using the brake (when in double drive operation), drape the band under the flyer. See peg picture above right.

**Tensioned lazy kate** - Screw two eyescrews into the pre-drilled holes on base. Insert the ends of the short piece (handle) into the pre-drilled holes at the top of the two long posts. Now press the bottom of the two longer posts into the base ensuring that the small hole in the handle is at the same end as the two eye screws. Glue base (but not handle) if you want to make a secure, permanent unit. Attach the Lazy Kate brake band by hooking the spring to the eyebolt closest to the corner of the lazy kate base. Thread the band through the other eyebolt and tie off the end of the band through the hole on the horizontal handle. You exert tension on bobbins by rotating the handle, winding the band around the handle. When using the tension option, make a "S" curve with the band around the pulleys on the bobbins; increase the braking action by turning the handle.

## Wheel adjustment

The Kromski Polonaise is very true to the style of wheel that originated in the Baltic and Scandinavian area of Europe. It is the only wheel we know of that holds to this design style. Today this style is typically called Norwegian. In this design, the crank and the footman are located inside the two wheel posts and the wheel rotates using "pin and cup" bearings. Because the wheel "floats" on these

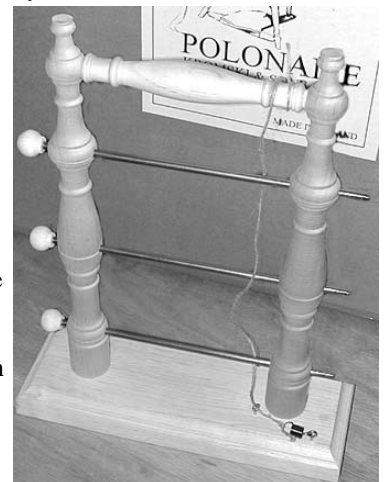
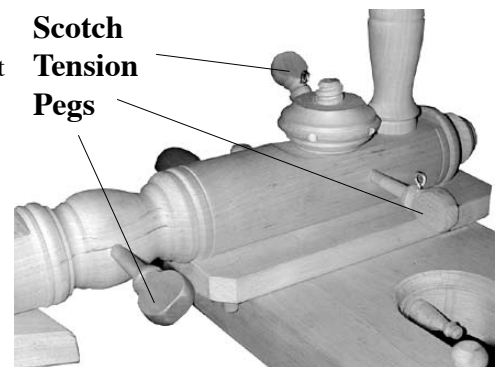

pins and because the wheel adjustment screws actually work (meaning you can turn them and something happens) the drive wheel can be displaced laterally. In an ideal spinning scenario, you want the wheel to always line up with the whorl and bobbin so that the drive band tracks well around the wheel and over the whorls. You adjust this (we call it aiming) tracking by turning the two wheel adjustment screws simultaneously but in opposite directions. Always rotate both screws the same amount and never one at a time.

The best way to “aim” the wheel is to stand looking at the wheel from the wheel end. Eyeball a straight line from the wheel to the gap between the bobbin and the whorl. You can do this with or without the drive band being on. If you want to “aim” the wheel more to your right, take hold of both wheel adjustment screws and rotate both of them out or away from the wheel. If you need to “aim” the wheel to the left, take hold of both wheel adjustment screws and rotate both of them in towards the wheel. You will see the wheel move on its axis in the direction you want. Once this adjustment is made you will not need to do this step again until you change whorl size, if then. Remember, always adjust the screws simultaneously, in opposite directions and in equal increments.

As with any new wheel, there will be a break-in period, not only for the wheel but for the spinner to get accustomed to the feel and adjustments that need to be made during spinning. Follow the lubrication suggestions below and then treadle for a while without spinning. New bobbins on new flyers sometimes can be sluggish. Make sure there is nothing on the shaft that will impede easy rotation of the bobbin. Make sure the treadle/footman connection is secure. Make sure the footman does not touch the bench (or make adjustments as noted above). Find the “sweet spot” on the treadle that will allow you to start the wheel from nearly any position without the use of your hand. The Polonaise has a good heel/toe feel: position your foot on the treadle so you can get this feel.

### **Maintenance**

All spinning wheels have points that require lubrication. On the Polonaise you need to regularly oil the following points:

Treadle ends where they enter the front legs

Leather bearings that support the flyer

Metal spindle shaft at both ends where the bobbin bearings ride

The footman/crank point

The two metal pin/cup bearings points on the wheel hub; alternately, you might want to put some petroleum jelly in the cups as it is less prone to dripping out.

Your Kromski Polonaise comes with a handy needle nose oiling bottle. It is ideal for all these locations. We recommend that all these points be oiled when you begin spinning for the day and you may want to oil the pin/cup bearing more often.

One other step you may care to do is waxing the wooden screw threads on the tension adjusting screw. To do this, remove the peg on the adjusting screw and back the screw out. Using a candle or a bar of paraffin (never soap), work the wax onto the threads from one end to the other. Reassemble and you should notice easier movement. You could also remove the other threaded parts on the mother-of-all and wax them as well. Do this after finishing the wood. Because the wheel adjusting screws move so little as you “aim” the wheel we do not think it is necessary to wax these; but you may.

**Kromski Spinning Wheels**

Imported and Distributed by

**New Voyager Trading**

**P.O. Box 468**

**Murfreesboro, NC 27855**

# Parts List - Kromski Polonaise

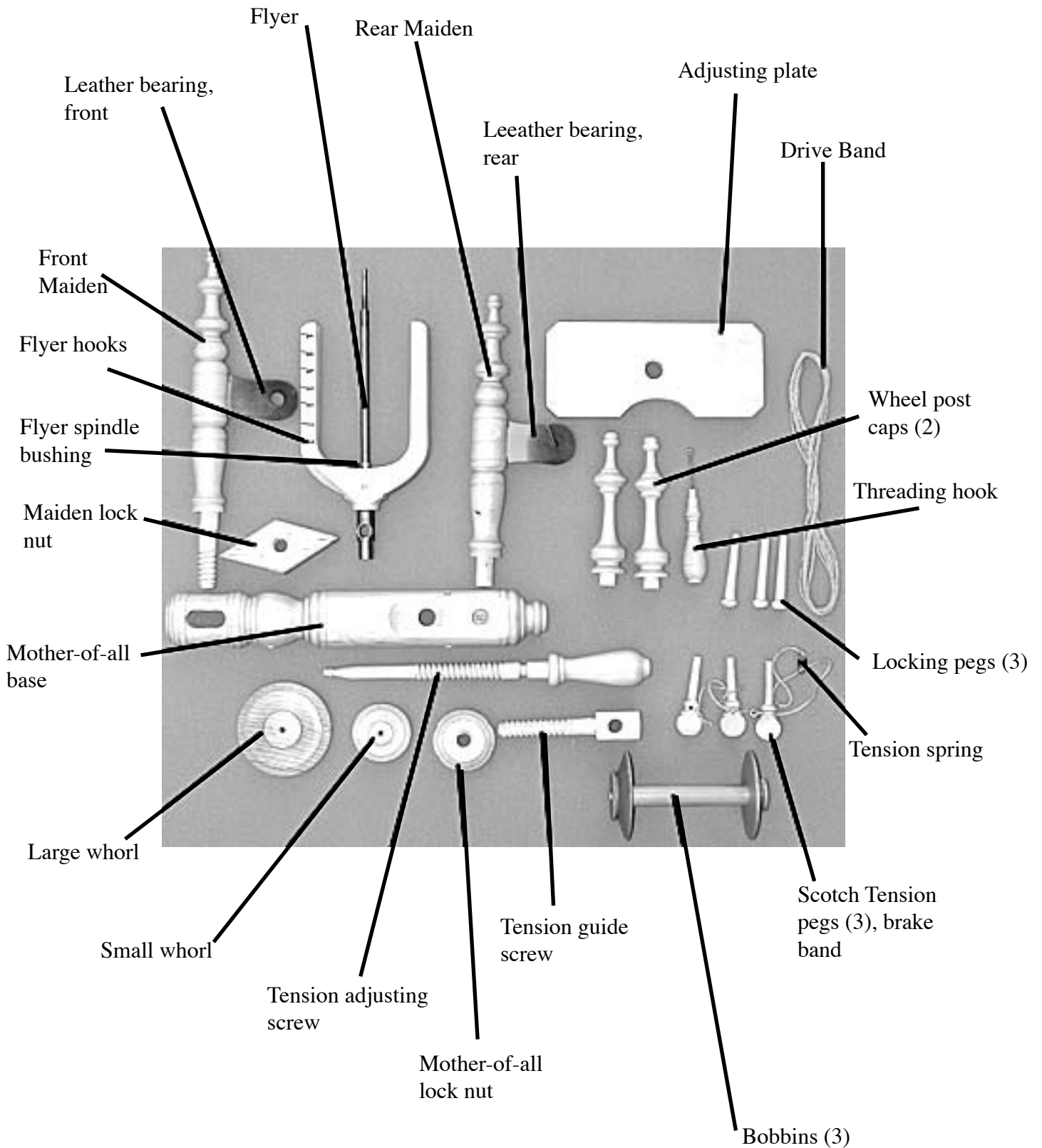

**Over** →

# Parts List - Kromski Polonaise

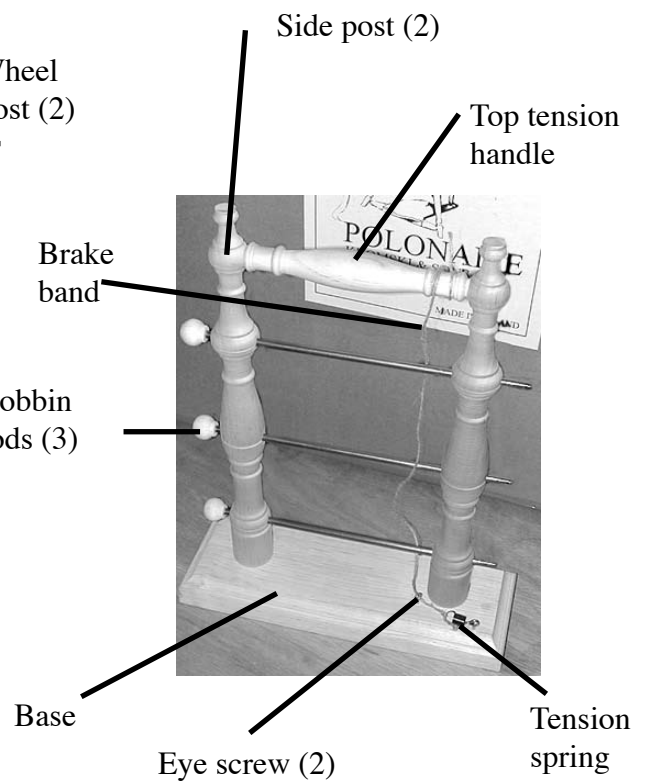
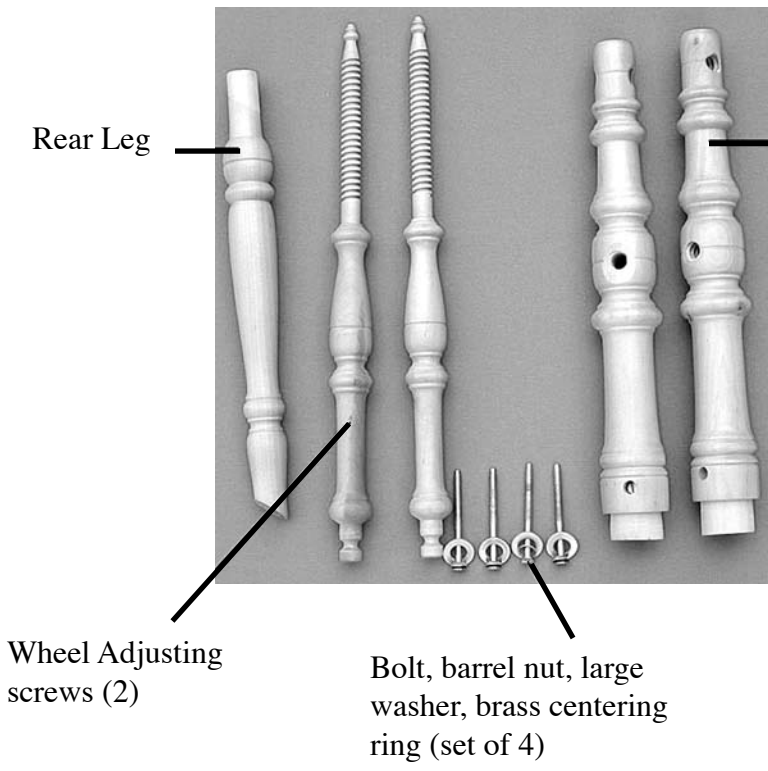
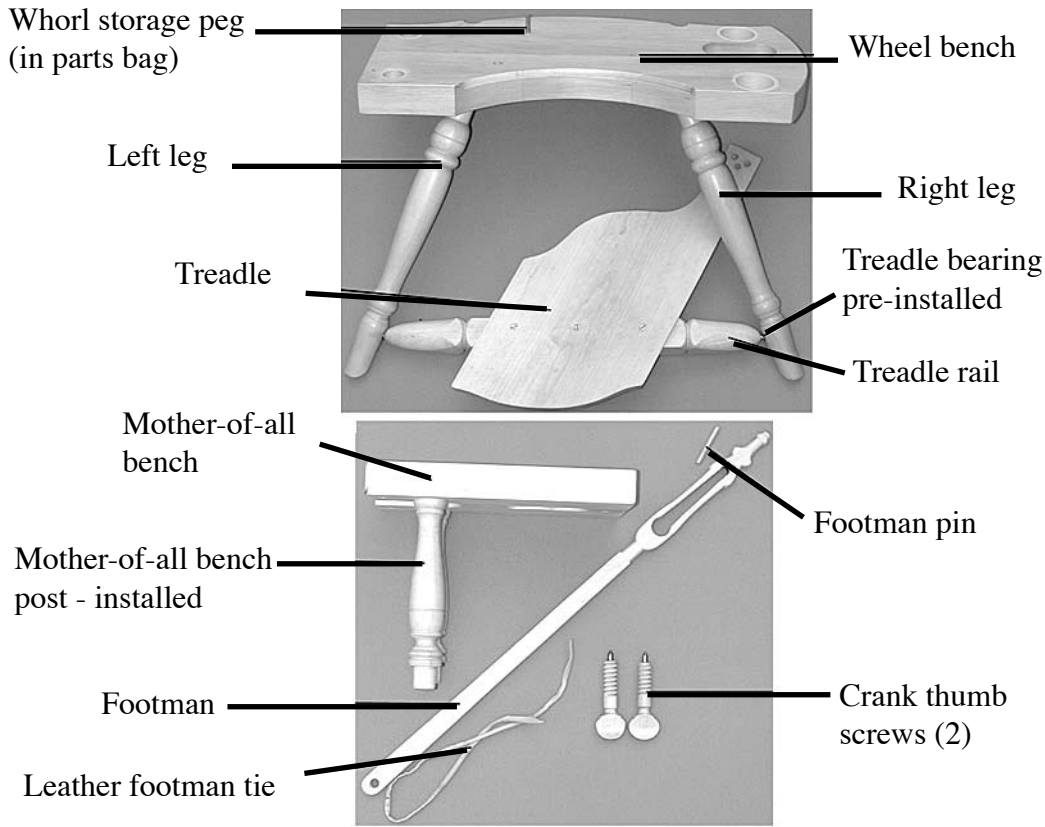

Over →

# Polonaise Assembly - by the picture

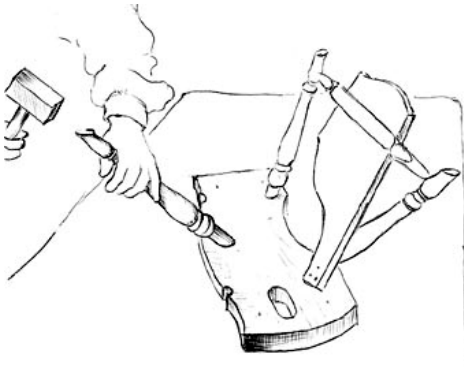

Step 1: Install rear leg. Glue in place if you prefer.

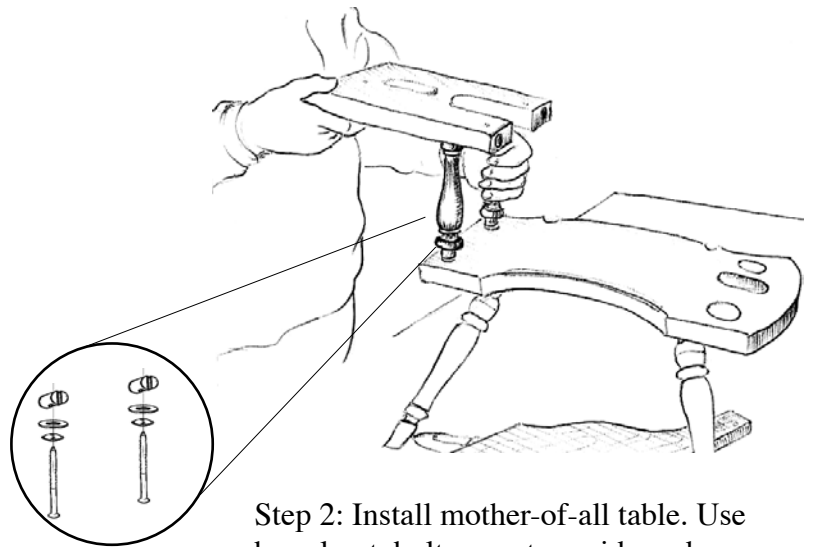

Step 2: Install mother-of-all table. Use barrel nut, bolt, a center guide and a washer. Use a screwdriver on nut to help line up hole. If your parts bag has long and short bolts, use short bolts here.

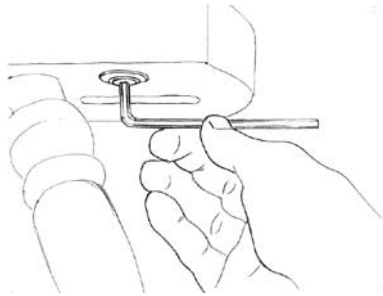

Step 3: Tighten bolt with allen wrench.

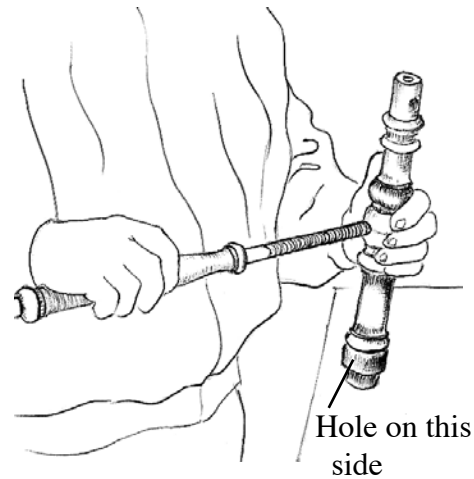

Step 4: Screw wheel adjusting screws (2) in to wheel posts (2); you will need to go all the way to the end. The screw starts on the same side as the small hole at bottom of the post.

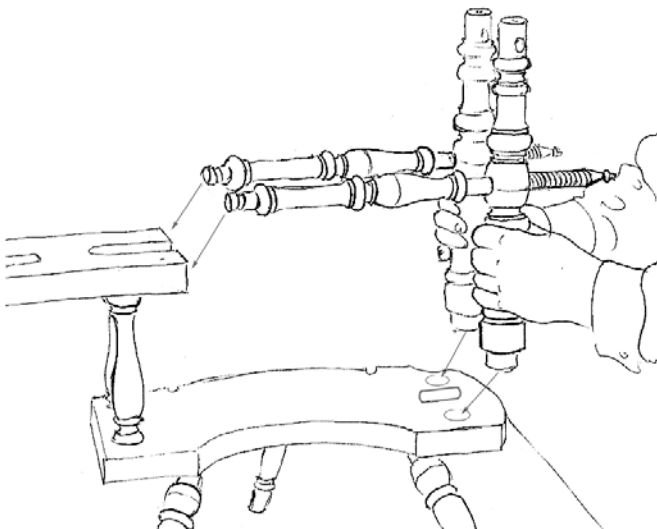

Step 5: Place the two wheel posts into the counter-sunk holes on the bench.

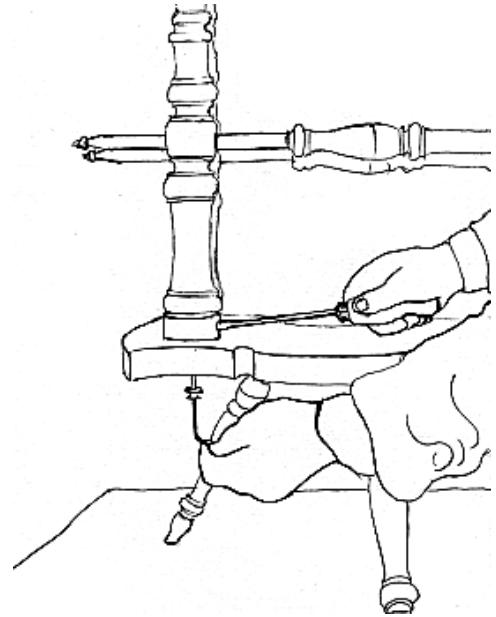
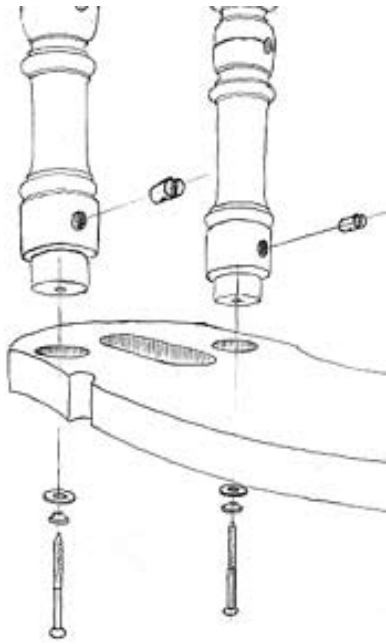

Step 6: Insert barrel nut into hole near the base of the post. Use a screwdriver to line up nut with bolt. Be sure to use centering ring and washer. Back adjusting screws into the two holes on the right edge of table to the point where you can see the peg notch by looking down through the peg hole. Insert a peg into each hole. Tighten the two bolts with the allen wrench. Do not rotate the two adjusting screws at this time.

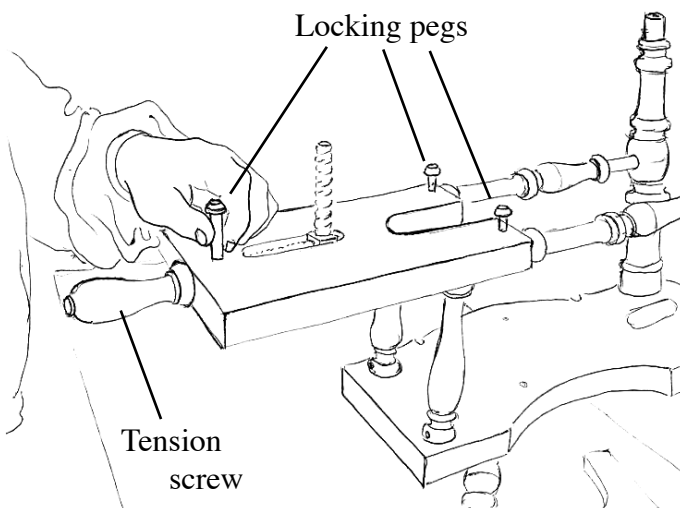
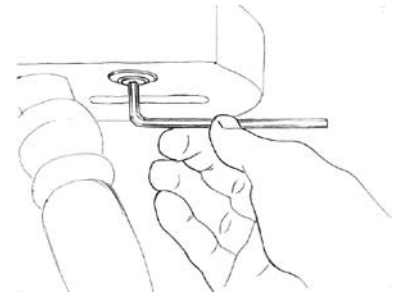

Step 7: Install tension adjusting screw through hole on left edge of table. Thread through the tension guide screw (threaded end up). Secure screw by inserting a peg into hole on top of the table.

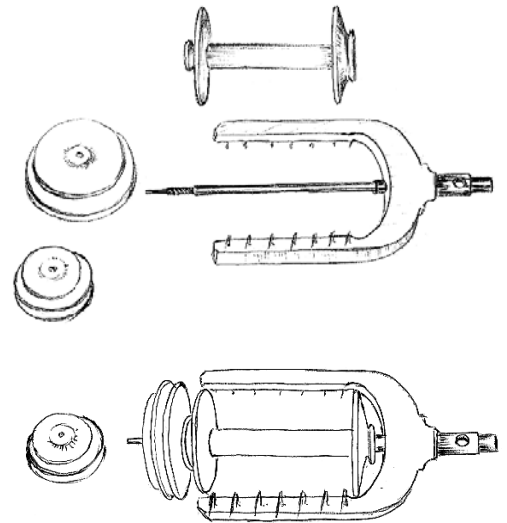
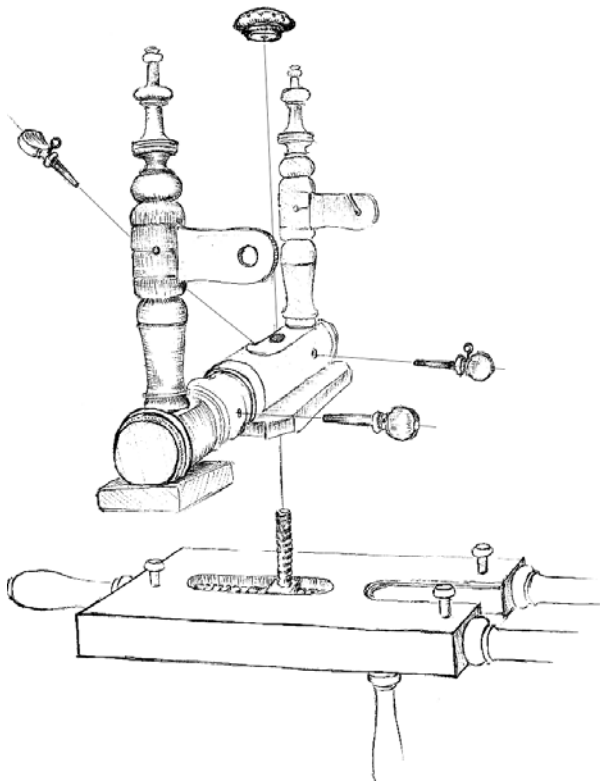

Step 8: Assemble the Mother-of-all as shown left. Place a bobbin on the flyer and screw on one whorl - nut side nearest the bobbin. **NOTE** - reverse threads on whorl; counterclockwise to put on, clockwise to remove.

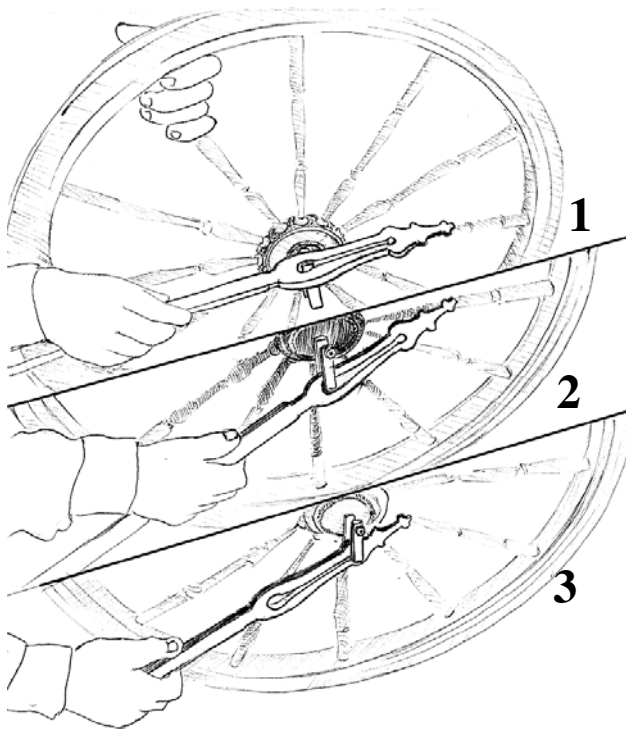

Step 9: Work the footman on the crank. Secure with long wooden pin.

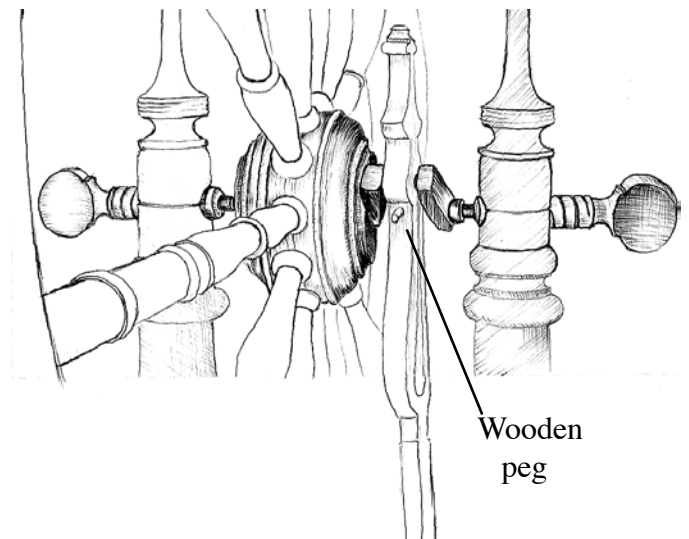

Step 10: Hang the wheel. The footman goes through the bench. Screw in the two thumb screws that support the wheel equal distances. The posts should deflect out a bit when the wheel is properly secure. Use more rather than less pressure. Footman should not touch bench hole as wheel turns.

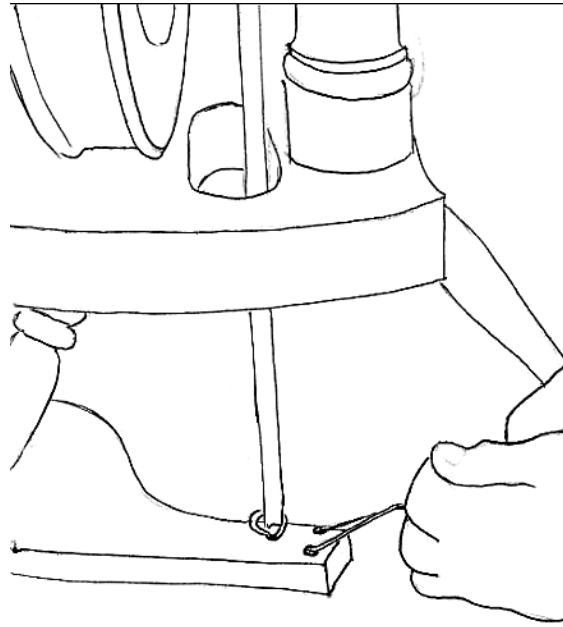

Step 11: Thread leather tie through bottom of footman; now thread the two ends through front hole on treadle. Bring each end up through the two remaining holes and tie off. Connection should be snug.

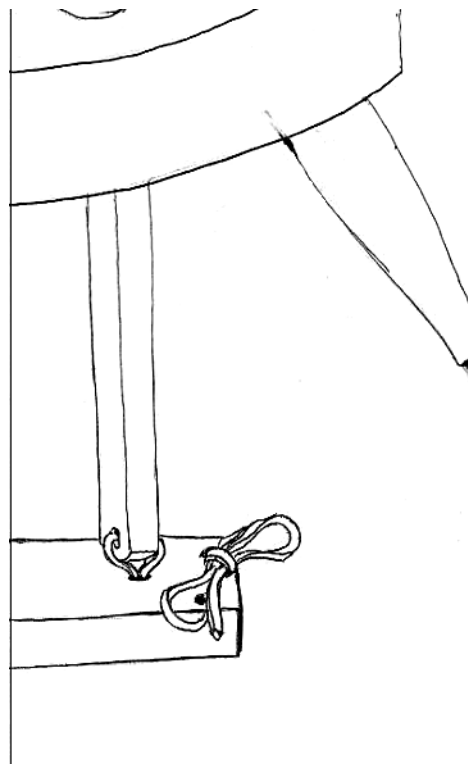

## Having Problems...

You have put your Polonaise together and it doesn't look right; the wheel doesn't line up with the flyer (yes, you have read the instructions but still...). Here is what some spinners have said:

- “you have a serious design flaw with the wheel”
- “the wheel does not line up with the flyer whorl regardless of the amount of adjusting I do with the thumb screws”
- “you mean those wheel adjusting screws really work?”

We admit that the manner of hanging the Polonaise wheel and the adjustments that have to be made to line up the wheel and flyer are different from almost all other wheels but it is the way this style of wheel was developed more than 100 years ago.

### Don'ts

- Don't attempt to line up the wheel and flyer with the thumb screws. The thumb screws are only used to hang/support the wheel and to adjust the wheel position if the footman touches the hole in the bench. The wheel is hung correctly when you can see deflection of the wheel posts as you turn the thumb screws.
- When assembling the wheel, don't “play” with the wheel adjusting screws until you are ready to line-up the wheel with the flyer. If you have, you can put them in “neutral” by removing the two locking pegs so you can reposition the notch in the wheel adjusting screw with the hole for the locking peg.
- Don't expect the wheel to be parallel with the bench, or the flyer to be perpendicular to the bench once everything is aligned. Both will need to be off at a slight angle. See below.

### Do's

- When the wheel is first mounted and there is no tension on the wheel adjusting screws (you did not play with them yet, have you?) the wheel will be parallel with the bench. Now you want to “aim” the wheel towards the whorl on the flyer. Do this by grasping both adjusting screws and rotating them, both in towards the wheel or both out, or away, from the wheel. Turn them an equal amount. Watch the rim of the wheel move so you can aim it at the whorl. You should end up with an imaginary line running from the middle of the wheel rim to the gap between the whorl and the bobbin.

Voila, wasn't that easy? Do this once when you change whorls, but otherwise it need not be done again.

If you have further questions, call your dealer for advice.



Exaggerated view of Polonaise before and after you adjust flyer and aim wheel.